

Filter & Flow Control Products for the Semiconductor Industry

HIGH PURITY





Table of Contents

About Mott.....	2-3
Gas Flow Schematic.....	4
Compatibility Guide.....	5
Gasket Filters.....	6-7
Point-of-Use Filters: 316L SS and Hastelloy® Porous Metal - Low Flow.....	8-9
Point-of-Use Filters: 316L SS and Hastelloy® Porous Metal - High Flow.....	10-11
Point-of-Use Filters: 316L SS Fiber Metal - Low Flow	12-13
Point-of-Use Filters: Nickel Porous Metal - Low Flow	14-17
Point-of-Use & Utility Filters: Nickel Porous Metal - High Flow	18-19
Bulk Gas Filters.....	20-21
Surface Mount C-Seal Filters.....	22-23
Surface Mount W-Seal Filters.....	24-25
Diffusers	26-27
Flow Restrictors.....	28-29
Lab Testing and Custom Engineering	30-31

TABLE OF CONTENTS

Your partner in semiconductor component design.

Mott is an industry leader when it comes to designing filtration and flow control parts for the semiconductor industry. In fact, we were pioneers in bringing all-metal gas filters for high purity gas filtration to semiconductor manufacturers decades ago.

Since that time, we have been engineering solutions to solve our customer's most complex challenges and are recognized for our troubleshooting expertise and flexibility in addressing their urgent needs. Our project and application engineers are committed to taking the extra time to ensure we surpass our customer's expectations — with each and every interaction.



Embrace the possibilities.

Bring us your challenge.

While today's semiconductor manufacturing process continues to become more complex, process chemicals are being pushed like never before to meet more stringent requirements that require precise filtration and flow control of gases at each step in the process. Filters must be able to remove particulate contamination from concentrated chemical mixtures often at elevated temperatures and under challenging conditions. For decades, engineers have relied on Mott high purity and GasShield® filters for applications with the most rigorous filtration standards.

Quality is at the core of our business.

Our manufacturing facilities are ISO 9001 certified — an accreditation we have proudly upheld since 1997. This quality system certification means that Mott adheres to a consistent,

independently verified method to manage its processes.

We also maintain Class 100 and Class 10,000 clean rooms that filter room air up to 300 times each hour to support the manufacture of contaminant-sensitive components used in semiconductor applications.

Our customers have long recognized the value of our quality management system and those in nearly 70 countries depend on us to ensure the quality of their products and services.

Solutions designed for the semiconductor industry.

To effectively compete in world markets, today's manufacturers face mounting pressure to maximize production yields while producing integrated circuits that are smaller, faster and contain more

memory. Controlling and eliminating contamination is one of the most significant concerns in the manufacture of semiconductors.

For an ultra pure chemical distribution system to be effective, it is essential to use the proper filters at each point of chemical handling or processing to ensure contamination-free delivery of these materials. From point-of-use and bulk filters to diffusers and flow restrictors, Mott offers a full line of products to meet the special needs of the semiconductor industry.

ABOUT MOTT

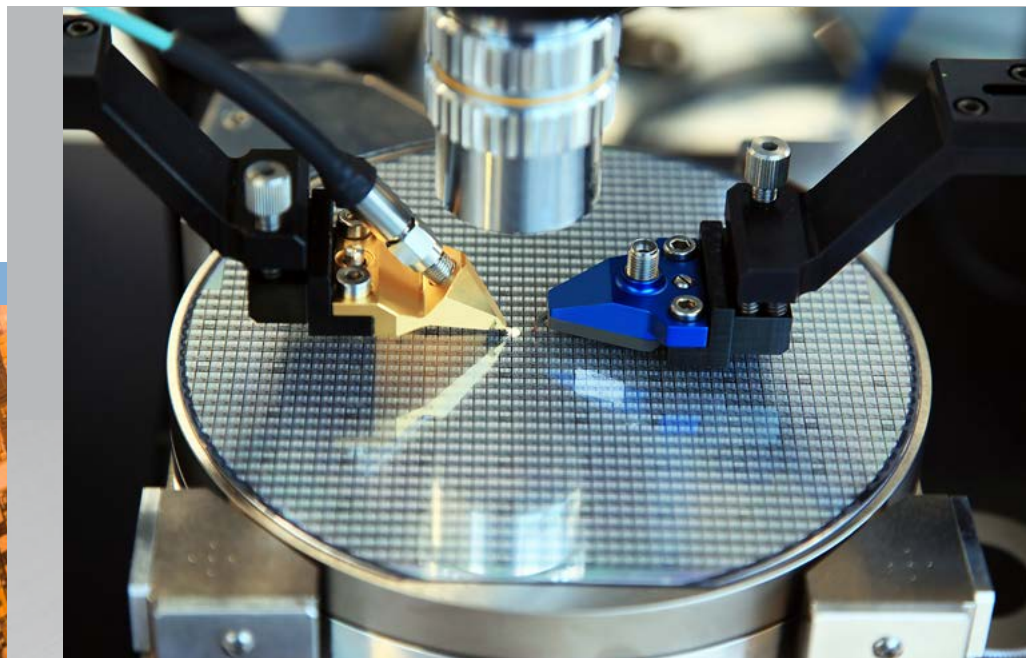

Choosing a Mott High Purity Gas Product

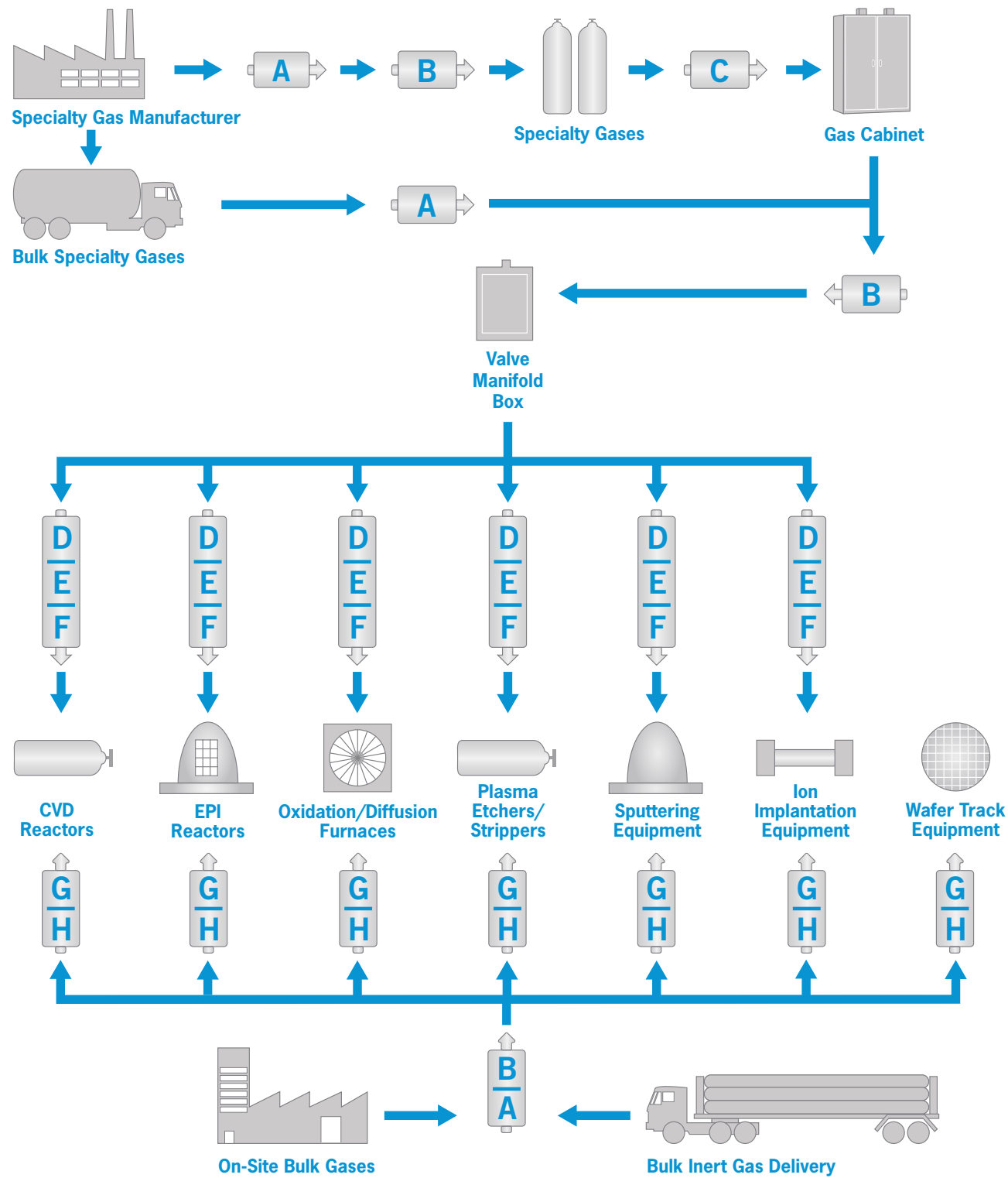

Filter Recommendation

Filter A	Bulk Gas Filter	Filter C	Point-of-Use Filter	Filter E	Surface Mount Filter	Filter G	Gas Diffusers
Filter B	Utility Filter	Filter D	Point-of-Use Filter	Filter F	High Purity Restrictor	Filter H	Point-of-Use Filter

Choosing the best metal filter is not always a simple matter, because, in addition to easily identified variables (i.e., gas, pressure and flow), there are subjective considerations. Some gases are compatible with more than one type of metal which allows you a choice when selecting the right filter for your application.

The information contained in this table is a guideline for appropriate filter selection. Consultation with your gas supplier is recommended to ensure gas compatibility. Because so many factors can affect the chemical resistance of a given product, you should pre-test under your unique operating conditions. As with any chemical application, always observe safety precautions as noted on SDS sheets.

With the following information, Mott's engineers can recommend the filter that best meets your application's needs.

- Type of Gas
- Gas Flow Rate
- Inlet (or system) Pressure: PSIG
- Maximum allowable ΔP : PSID
- Size and Type of inlet/outlet connection
- Available Envelope/Footprint Dimensions (if known)

SS = 316L Stainless Steel
 Ni = Nickel
 H = Hastelloy® C-22
 (1) - Compatible less than room temp and less than 1000 ppm.

COMPATIBILITY GUIDE

Gas	Chemical Formula	Suggested Filter Media
Ammonia	NH3	SS/Ni
Argon	Ar	SS/Ni
Arsenic Pentafluoride	AsF5	SS/Ni
Arsine	AsH3	SS/Ni(1)
Boron Trichloride	BCl3	Ni/H
Boron Trifluoride	BF3	Ni/H
Carbon Dioxide	CO2	SS/Ni
Carbon Monoxide	CO	SS
Carbon Tetrachloride	CCl4	SS/Ni
Carbon Tetrafluoride	CF4	SS/Ni
Chlorine	Cl2	SS/Ni/H
Diborane	B2H6	SS/Ni(1)
Dichlorosilane	SiH2Cl2	Ni/H
Diethyltelluride	C4H10Te	SS/Ni
Fluorine	F2	Ni/H
Freon 13	CClF3	SS/Ni
Freon 14 Tetrafluoromethane	CF4	SS/Ni
Freon 23 Trifluoromethane/Fluoro-form	CHF3	SS/Ni
Freon 115 Chloropentafluoroethane	C2ClF5	SS/Ni
Freon 116 Hexafluoroethane	C2F6	SS/Ni
Germane	GeH4	SS/Ni
Helium	He	SS/Ni
Hydrogen	H2	SS/Ni
Hydrogen Bromide	HBr	Ni/H
Hydrogen Chloride	HCl	Ni/H
Hydrogen Fluoride	HF	Ni/H
Hydrogen Selenide	H2Se	SS/Ni
Hydrogen Sulfide	H2S	SS/Ni
Krypton	Kr	SS/Ni
Methane	CH4	SS/Ni
Methyl Fluoride	CH3F	SS/Ni
Nitric Oxide	NO	SS/Ni
Nitrogen	N2	SS/Ni
Nitrogen Trifluoride	NF3	SS/Ni/H
Nitrous Oxide	N2O	SS/Ni
Neon	Ne	SS/Ni
Oxygen	O2	SS/Ni
Ozone	O3	H
Perfluoropropane	C3F8	SS/Ni
Phosphine	PH3	SS/Ni(1)
Phosphorus Trifluoride	PF3	Ni/H
Phosphorous Pentachloride	PCl5	SS/Ni
Phosphorous Pentafluoride	PF5	SS/Ni
Silane	SiH4	SS/Ni
Silicon Tetrachloride	SiCl4	Ni/H
Silicon Tetrafluoride	SiF4	Ni/H
Stibine	SbH3	SS/Ni
Sulfur Hexafluoride	SF6	SS/Ni
Tetraethyl Orthosilicate	TEOS	SS/Ni
Trichlorosilane	SiHCl3	Ni/H
Trimethyl Borane	C3H9B	SS/Ni
Trimethyl Phosphate	C3H9PO4	SS/Ni
Tungsten Hexafluoride	WF6	Ni/H
Xenon	Xe	SS/Ni

GasShield® Gasket Filters



Description

GasShield® Gasket Filters are available in nickel and 316L stainless steel and fit inside 1/4", 3/8" and 1/2" face seal fittings. They retain particles down to 0.003 µm, are compatible with most inert and specialty gases, and integrate into the gas system without adding length.

Applications

Gasket filters are designed to protect critical components like mass flow controllers, regulators, and valves in semiconductor gas distribution systems.

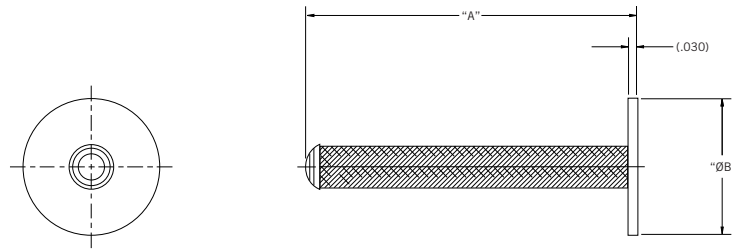

SAMPLE FLOW DATA

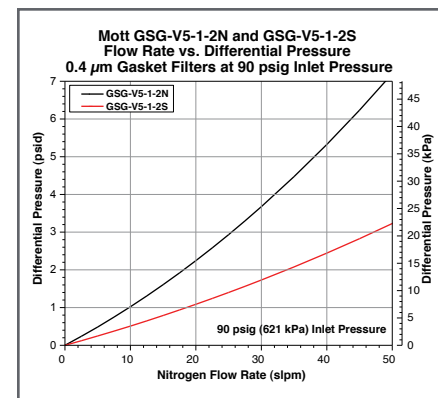
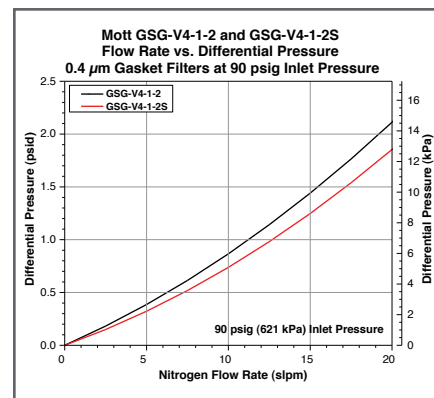
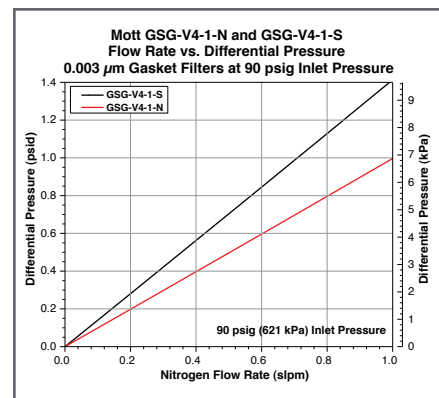

ORDERING INFORMATION

Part Description	Part Number	Rated Flow	Filter Media	A Inches/mm	B Inches/mm
GSG-V4-1-N	2324100	1 SLPM	Nickel	1.1/27.9	0.47/11.9
GSG-V4-3-N	2324102	3 SLPM	Nickel	3.1/78.7	0.47/11.9
GSG-V4-1-2	2324004	20 SLPM	Nickel	1.0/25.4	0.47/11.9
GSG-V5-1-2N	2324118	50 SLPM	Nickel	1.0/25.4	0.78/19.8
GSG-V4-1-S	2324110	1 SLPM	316L SS	1.0/25.4	0.47/11.9
GSG-V4-3-S	2324112	3 SLPM	316L SS	3.0/76.2	0.47/11.9
GSG-V4-1-2S	2324109	20 SLPM	316L SS	1.0/25.4	0.47/11.9
GSG-V5-1-2S	2324116	50 SLPM	316L SS	1.0/25.4	0.78/19.8

*Custom designs and fittings available. Contact a Mott representative for more information.

SPECIFICATIONS

Rated Flow	1 SLPM	3 SLPM	20 SLPM	50 SLPM
Retention at Rated Flow	Greater than 99.999999 (9 log) removal of all particles down to 0.003 µm; confirmed at the most penetrating particle size of 0.08 µm.		0.4 µm nominal	0.4 µm nominal
Helium Leak Rating:	1 x 10 ⁻⁹ atm cc/sec			
Moisture Contribution:	<10 ppb after 1 hour at low-flow ambient purge per SEMI F27 test method			
Total Hydrocarbons:	Below detectable limits per ASTM F1398 test method			
Particle Shedding:	Zero particle contribution above background (<1 particle/ft ³) per SEMI F43-0308 test method			
Maximum Operating Temperature	450° C			

GASKET FILTERS

GasShield® Point-of-Use Filters



Description

Mott high purity gas filters provide 9-log filtration of particles down to 0.0015 µm resulting in particle-free gas. For maximum gas filtration efficiency, strength and reliability, GasShield point-of-use gas filters are ideal for ultra high purity gas delivery applications. They are compatible with most high purity electronics grade process gases.

Applications

Ultra high purity corrosive gas filtration in the following applications: gas sticks for equipment hookup, valve manifold boxes, gas cabinets, tool isolation gas boxes, and on-board OEM tool gas boxes.

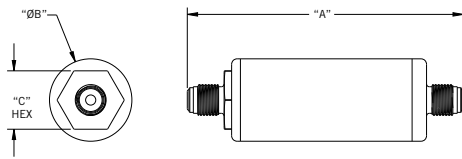

SAMPLE FLOW DATA

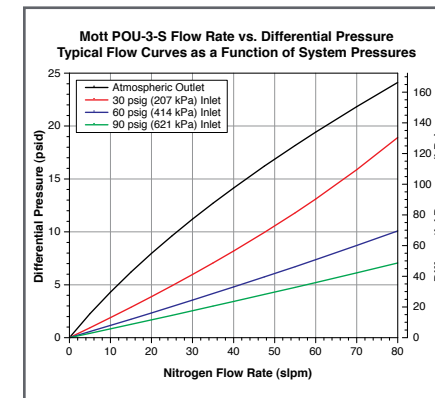
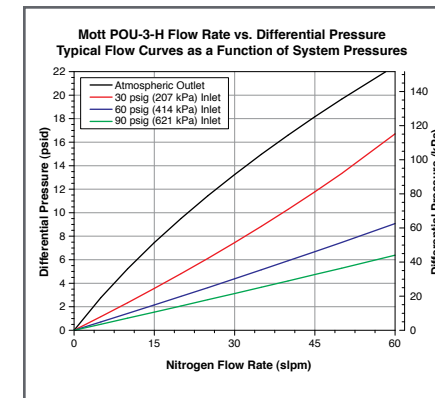
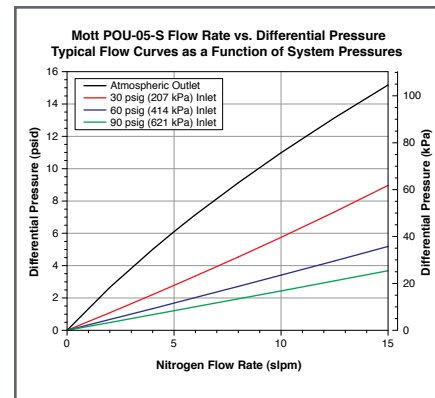
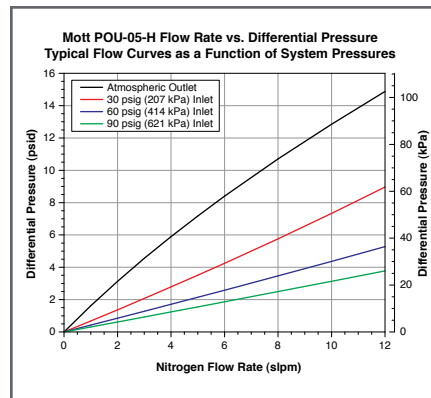
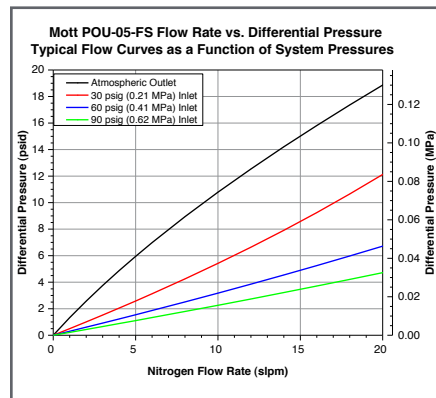

WARRANTY

Mott Corporation ("Mott") warrants its GasShield filter will meet the specified retention and media integrity standards for a period of five years from the date of purchase, providing the filter is properly installed and used in accordance with the specified flow, pressure, temperature, and chemical compatibility as published by Mott. Mott will replace or grant a purchase price refund for any GasShield filter which proves defective under the terms of this limited warranty.

ORDERING INFORMATION

Part Description	Part Number	Fitting Type	Hardware Material	Filter Media	Surface Finish	Max Operating Pressure	Max Differential Pressure	A Inches/mm	B Inches/mm	C Inches/mm
POU-05-FSV1	6700015	1/4 inch Male/Male Face Seal	316L SS	316L SS Fiber	5 Ra, Electro-polished	3000 psig (206.8 barg)	1000 psid (68.9 bar)	3.31/84.0	0.75/19.0	0.625/15.9
POU-05-HV1	6800040	1/4 inch Male/Male Face Seal	Hastelloy® C-22	Hastelloy® C-22	5 Ra	3750 psig (258.5 barg)	1000 psid (68.9 bar)	3.31/84.0	0.75/19.0	0.812/20.6
POU-05-ST1	6800059	1/4 inch Butt Weld Tube Stub	316L SS	316L SS	5 Ra, Electro-polished	3750 psig (258.5 barg)	1000 psid (68.9 bar)	3.31/84.0	0.75/19.0	N/A
POU-3-HV1	6800002	1/4 inch Male/Male Face Seal	Hastelloy® C-22	Hastelloy® C-22	5 Ra	3750 psig (258.5 barg)	1000 psid (68.9 bar)	3.31/84.0	1.50/38.1	1.062/26.9
POU-3-HV3	6800148	1/2 inch Male/Male Face Seal	Hastelloy® C-22	Hastelloy® C-22	5 Ra	3750 psig (258.5 barg)	1000 psid (68.9 bar)	3.31/84.0	1.50/38.1	1.062/26.9
POU-3-HSV1	6800045	1/4 inch Male/Male Face Seal	316L SS	Hastelloy® C-22	5 Ra, Electro-polished	2500 psig (172.4 barg)	1000 psid (68.9 bar)	3.31/84.0	1.50/38.1	1.062/26.9
POU-3-HSV3	6800180	1/2 inch Male/Male Face Seal	316L SS	Hastelloy® C-22	5 Ra, Electro-polished	2500 psig (172.4 barg)	1000 psid (68.9 bar)	3.31/84.0	1.50/38.1	1.062/26.9
POU-3-SV1	6800001	1/4 inch Male/Male Face Seal	316L SS	316L SS	5 Ra, Electro-polished	2500 psig (172.4 barg)	1000 psid (68.9 bar)	3.31/84.0	1.50/38.1	1.062/26.9
POU-3-SV3	6800079	1/2 inch Male/Male Face Seal	316L SS	316L SS	5 Ra, Electro-polished	2500 psig (172.4 barg)	1000 psid (68.9 bar)	3.31/84.0	1.50/38.1	1.062/26.9

*Custom designs and fittings available. Contact a Mott representative for more information.

SPECIFICATIONS

Particle Removal Size:	≥ 0.0015 µm
Filter Efficiency (Log Reduction Value):	≥ 9 LRV (99.9999999% reduction in particles). Confirmed at the most penetrating particle size of 0.08 µm per SEMI F38-0699 test method
Helium Leak Rating:	1 x 10 ⁻⁹ atm cc/sec
Moisture Contribution:	<10 ppb after 1 hour at low-flow ambient purge per SEMI F27 test method
Total Hydrocarbons:	Below detectable limits per ASTM F1398 test method
Particle Shedding:	Zero particle contribution above background (<1 particle/ft ³) per SEMI F43-0308 test method
Maximum Operating Temperature	450° C

POINT-OF-USE FILTERS

GasShield® Point-of-Use Filters (continued)



Description

Mott high purity gas filters provide 9-log filtration of particles down to 0.0015 µm resulting in particle-free gas. For maximum gas filtration efficiency, strength and reliability, GasShield point-of-use gas filters are ideal for ultra high purity gas delivery applications. They are compatible with most high purity electronics grade process gases.

Applications

Ultra high purity corrosive gas filtration in the following applications: gas sticks for equipment hookup, valve manifold boxes, gas cabinets, tool isolation gas boxes, and on-board OEM tool gas boxes.

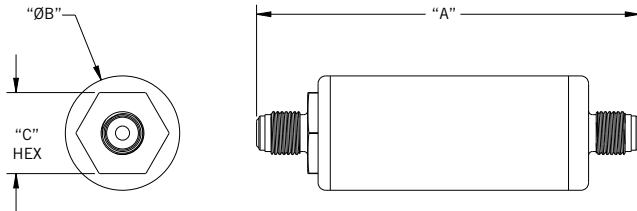

SAMPLE FLOW DATA

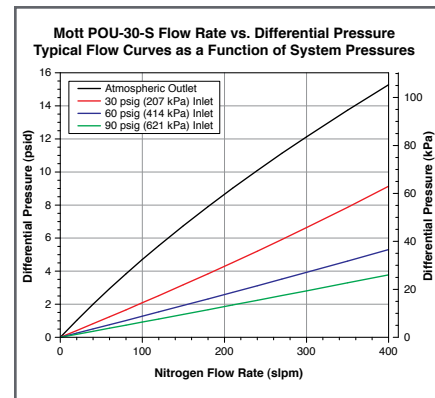
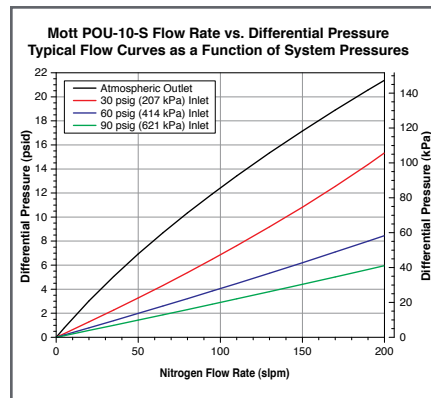
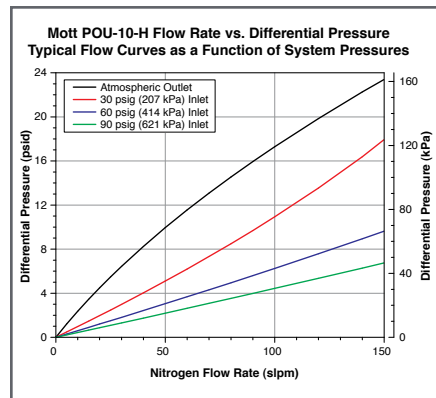

WARRANTY

Mott Corporation ("Mott") warrants its GasShield filter will meet the specified retention and media integrity standards for a period of five years from the date of purchase, providing the filter is properly installed and used in accordance with the specified flow, pressure, temperature, and chemical compatibility as published by Mott. Mott will replace or grant a purchase price refund for any GasShield filter which proves defective under the terms of this limited warranty.

ORDERING INFORMATION

Part Description	Part Number	Fitting Type	Hardware Material	Filter Media	Surface Finish	Max Operating Pressure	Max Differential Pressure	A Inches/mm	B Inches/mm	C Inches/mm
POU-10-HV1	6800004	1/4 inch Male/Male Face Seal	Hastelloy® C-22	Hastelloy® C-22	5 Ra	3750 psig (258.5 barg)	1000 psid (68.9 bar)	5.00/127.0	1.50/38.1	1.062/26.9
POU-10-HV3	6800178	1/2 inch Male/Male Face Seal	Hastelloy® C-22	Hastelloy® C-22	5 Ra	3750 psig (258.5 barg)	1000 psid (68.9 bar)	5.00/127.0	1.50/38.1	1.062/26.9
POU-10-HSV1	6800046	1/4 inch Male/Male Face Seal	316L SS	Hastelloy® C-22	5 Ra, Electro-polished	2500 psig (172.5 barg)	1000 psid (68.9 bar)	5.00/127.0	1.50/38.1	1.062/26.9
POU-10-HSV3	6800181	1/2 inch Male/Male Face Seal	316L SS	Hastelloy® C-22	5 Ra, Electro-polished	2500 psig (172.5 barg)	1000 psid (68.9 bar)	5.00/127.0	1.50/38.1	1.062/26.9
POU-10-SV1	6800003	1/4 inch Male/Male Face Seal	316L SS	316L SS	5 Ra, Electro-polished	2500 psig (172.5 barg)	1000 psid (68.9 bar)	5.00/127.0	1.50/38.1	1.062/26.9
POU-10-SV3	6800007	1/2 inch Male/Male Face Seal	316L SS	316L SS	5 Ra, Electro-polished	2500 psig (172.5 barg)	1000 psid (68.9 bar)	5.00/127.0	1.50/38.1	1.062/26.9
POU-10-ST1	6800011	1/4 inch Butt Weld Tube Stub	316L SS	316L SS	5 Ra, Electro-polished	2500 psig (172.5 barg)	1000 psid (68.9 bar)	5.00/127.0	1.50/38.1	N/A
POU-10-ST3	6800073	1/2 inch Butt Weld Tube Stub	316L SS	316L SS	5 Ra, Electro-polished	2500 psig (172.5 barg)	1000 psid (68.9 bar)	5.00/127.0	1.50/38.1	N/A
POU-30-SV3	6800074	1/2 inch Male/Male Face Seal	316L SS	316L SS	5 Ra, Electro-polished	2500 psig (172.5 barg)	1000 psid (68.9 bar)	11.22/285.0	1.50/38.1	1.062/26.9
POU-30-ST3	6800140	1/2 inch Butt Weld Tube Stub	316L SS	316L SS	5 Ra, Electro-polished	2500 psig (172.5 barg)	1000 psid (68.9 bar)	11.22/285.0	1.50/38.1	N/A

*Custom designs and fittings available. Contact a Mott representative for more information.

SPECIFICATIONS

Particle Removal Size:	≥ 0.0015 µm
Filter Efficiency (Log Reduction Value):	≥ 9 LRV (99.9999999% reduction in particles). Confirmed at the most penetrating particle size of 0.08 µm per SEMI F38-0699 test method
Helium Leak Rating:	1 x 10 ⁻⁹ atm cc/sec
Moisture Contribution:	<10 ppb after 1 hour at low-flow ambient purge per SEMI F27 test method
Total Hydrocarbons:	Below detectable limits per ASTM F1398 test method
Particle Shedding:	Zero particle contribution above background (<1 particle/ft ³) per SEMI F43-0308 test method
Maximum Operating Temperature	450° C

POINT-OF-USE FILTERS



GasShield® Defender Series



Description

GasShield® Defender is a line of ultra high purity gas filters that incorporates Mott's exclusive all fiber metal media. Defender meets the demands of ultra high purity gas delivery applications with a 9 LRV (log reduction value) of particles down to 0.0015 µm.

Applications

Ultra high purity gas sticks for semiconductor, LED, photovoltaic, and MEMS equipment hookup. Ultra high purity filtration in valve manifold boxes, gas cabinets, tool isolation gas boxes, on-board gas delivery boxes or any process requiring ultra high purity particle removal.

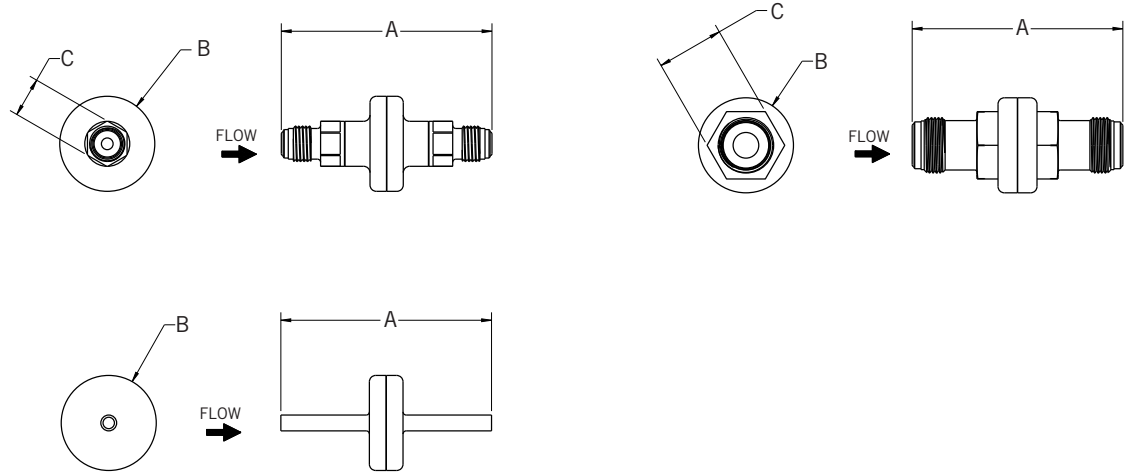

SAMPLE FLOW DATA

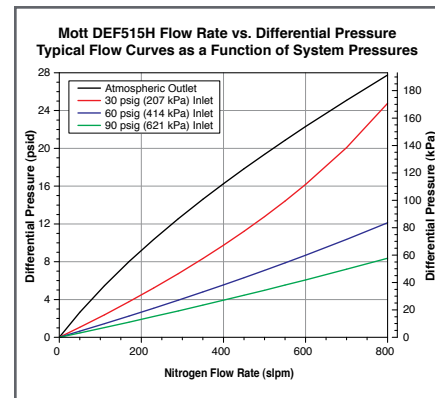
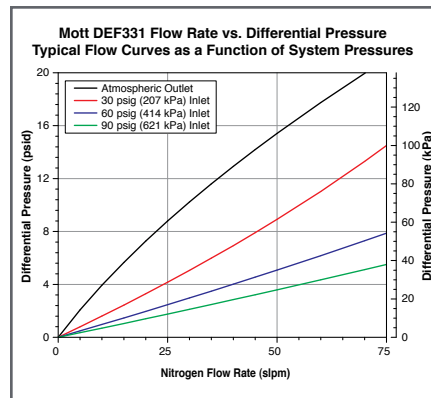
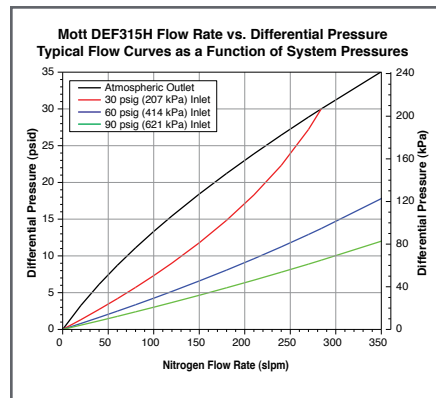

WARRANTY

Mott Corporation ("Mott") warrants its GasShield filter will meet the specified retention and media integrity standards for a period of five years from the date of purchase, providing the filter is properly installed and used in accordance with the specified flow, pressure, temperature, and chemical compatibility as published by Mott. Mott will replace or grant a purchase price refund for any GasShield filter which proves defective under the terms of this limited warranty.

ORDERING INFORMATION

Part Description	Part Number	Fitting Type	Hardware Material	Filter Media	Surface Finish	Max Operating Pressure	Max Differential Pressure	A Inches/mm	B Inches/mm	C Inches/mm
DEF331FF11	6700001	1/4 inch Male/Male Face Seal	316L SS	316L SS Fiber	10 Ra, Electro-polished	3000 psig (206.8 barg)	1000 psid (68.9 bar)	3.31/84.0	1.50/38.1	0.625/15.9
DEF280FP11	6700010	1/4 inch Male/Female Face Seal	316L SS	316L SS Fiber	10 Ra, Electro-polished	3000 psig (206.8 barg)	1000 psid (68.9 bar)	2.80/71.1	1.50/38.1	0.625/15.9
DEF112TT11	6700007	1/4 inch Butt Weld Tube Stubs	316L SS	316L SS Fiber	10 Ra, Electro-polished	3000 psig (206.8 barg)	1000 psid (68.9 bar)	1.12/28.4	1.50/38.1	N/A
DEF315HFF33	6712201	1/2 inch Male/Male Face Seal	316L SS	316L SS Fiber	5 Ra, Electro-polished	2500 psig (172.5 barg)	500 psid (34.5 bar)	3.31/84.0	1.50/38.1	1.062/26.9
DEF515HFF33	6712301	1/2 inch Male/Male Face Seal	316L SS	316L SS Fiber	5 Ra, Electro-polished	2500 psig (172.5 barg)	500 psid (34.5 bar)	5.00/127.0	1.50/38.1	1.062/26.9

*Custom designs and fittings available. Contact a Mott representative for more information.

SPECIFICATIONS

Particle Removal Size:	≥ 0.0015 µm
Filter Efficiency (Log Reduction Value):	≥ 9 LRV (99.9999999% reduction in particles). Confirmed at the most penetrating particle size of 0.08 µm per SEMI F38-0699 test method
Helium Leak Rating:	1 x 10 ⁻⁹ atm cc/sec
Moisture Contribution:	<10 ppb after 1 hour at low-flow ambient purge per SEMI F27 test method
Total Hydrocarbons:	Below detectable limits per ASTM F1398 test method
Particle Shedding:	Zero particle contribution above background (<1 particle/ft ³) per SEMI F43-0308 test method
Maximum Operating Temperature	450° C

DEFENDER SERIES



No other remedies apply. Mott disclaims all other warranties, either expressed or implied, including any warranty of merchantability or fitness for a particular purpose. Mott shall have no liability for consequential incidental, special or punitive damages, lost profits or savings, or damages from lost production or damage to other materials.

Sentry Series Point-of-Use Gas Filters



Description

The Sentry Series point-of-use filters are cost-effective, all-metal, ultra high purity gas filters that utilize Mott patented Penta nickel media and provide 9-log filtration of particles down to 0.0015 μm , resulting in particle-free gas.

Applications

Ultra high purity gas sticks for semiconductor, LED, photovoltaic and MEMS equipment hookup. Ultra high purity filtration in valve manifold boxes, gas cabinets, tool isolation gas boxes, on-board gas delivery boxes or any process requiring ultra high purity particle removal.

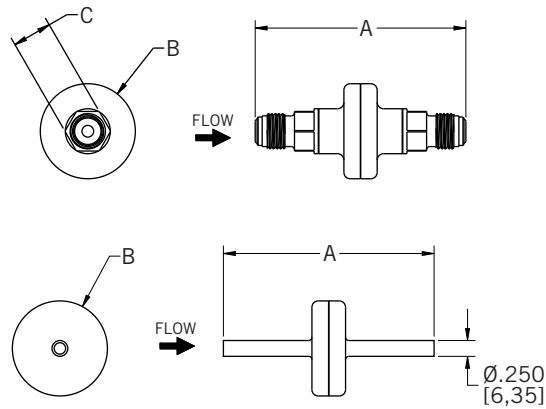

SAMPLE FLOW DATA

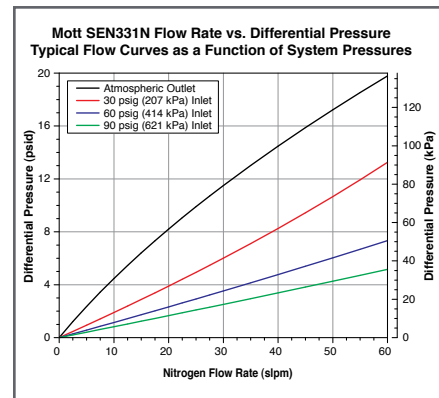

ORDERING INFORMATION

Part Description	Part Number	Fitting Type	Hardware Material	Filter Media	Surface Finish	Max Operating Pressure	Max Differential Pressure	A Inches/mm	B Inches/mm	C Inches/mm
SEN331NFF11	6815001	1/4 inch Male/Male Face Seal	316L SS	Penta Nickel	10 Ra, Electro-polished	3000 psig (206.8 barg)	500 psig (34.5 bar)	3.31/84.0	1.50/38.1	0.625/15.9
SEN280NFP11	6815005	1/4 inch Male/Female Face Seal	316L SS	Penta Nickel	10 Ra, Electro-polished	3000 psig (206.8 barg)	500 psig (34.5 bar)	2.81/71.3	1.50/38.1	0.625/15.9
SEN112NT11	6815004	1/4 inch Butt Weld Tube Stubs	316L SS	Penta Nickel	10 Ra, Electro-polished	3000 psig (206.8 barg)	500 psig (34.5 bar)	1.12/28.4	1.50/38.1	N/A

*Custom designs and fittings available. Contact a Mott representative for more information.

SPECIFICATIONS

Particle Removal Size:	$\geq 0.0015 \mu\text{m}$
Filter Efficiency (Log Reduction Value):	≥ 9 LRV (99.9999999% reduction in particles). Confirmed at the most penetrating particle size of 0.08 μm per SEMI F38-0699 test method
Helium Leak Rating:	1 x 10 ⁻⁹ atm cc/sec
Moisture Contribution:	<10 ppb after 1 hour at low-flow ambient purge per SEMI F27 test method
Total Hydrocarbons:	Below detectable limits per ASTM F1398 test method
Particle Shedding:	Zero particle contribution above background (<1 particle/ft ³) per SEMI F43-0308 test method
Maximum Operating Temperature	450° C

SENTRY

GasShield® Penta® Point-of-Use & Utility Filters

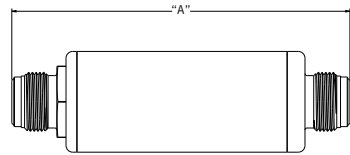
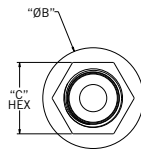

Description

For high flow gas filtration efficiency, strength, and reliability, GasShield Penta® all-metal gas filters are ideal for ultra high purity gas delivery applications. They are offered in all welded 316L stainless steel housings with Penta® Nickel filter media and are compatible with most high purity semiconductor process gases. These filters provide 9-log filtration of particles down to 0.0015 µm.

Applications

High flow bulk specialty gas supply, ultra high purity gas sticks for semiconductor, LED, photovoltaic and MEMS equipment hookup. Ultra high purity filtration in valve manifold boxes, gas cabinets, tool isolation gas boxes, on-board gas delivery boxes or any process requiring ultra high purity particle removal.

SAMPLE FLOW DATA

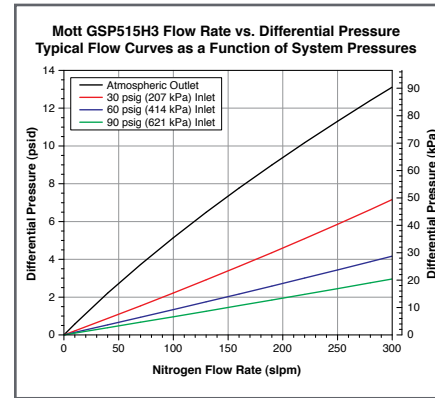
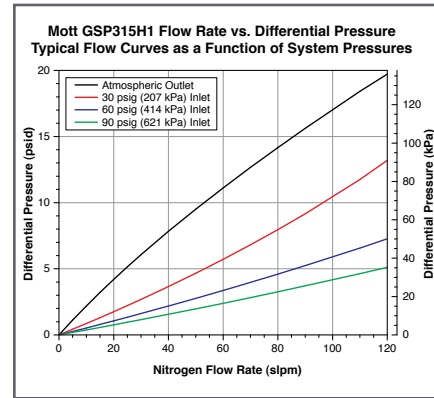
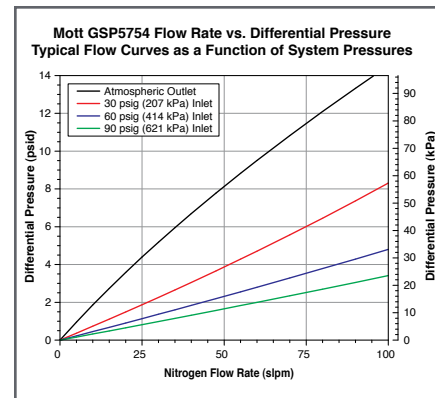
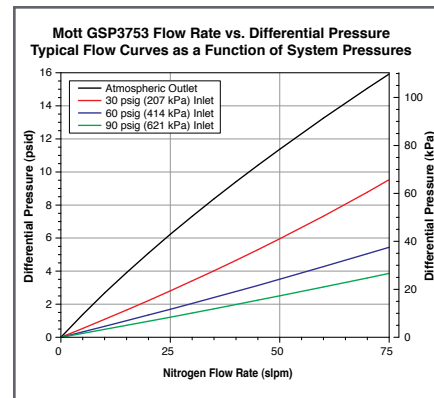
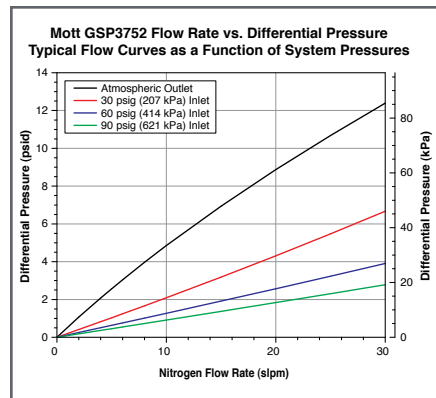

ORDERING INFORMATION

Part Description	Part Number	Fitting Type	Hardware Material	Filter Media	Surface Finish	Max Operating Pressure	Max Differential Pressure	A Inches/mm	B Inches/mm	C Inches/mm
GSP3752FF11	6812001	1/4 inch Male/Male Face Seal	316L SS	Penta Nickel	5 Ra, Electro-polished	3750 psig (258.5 barg)	500 psid (34.5 bar)	3.31/84.0	0.75/19.0	0.812/20.6
GSP3752TT11	6812019	1/4 inch Butt Weld Tube Stub	316L SS	Penta Nickel	5 Ra, Electro-polished	3750 psig (258.5 barg)	500 psid (34.5 bar)	3.31/84.0	0.75/19.0	N/A
GSP3753FF11	6812002	1/4 inch Male/Male Face Seal	316L SS	Penta Nickel	5 Ra, Electro-polished	3750 psig (258.5 barg)	500 psid (34.5 bar)	3.31/84.0	0.75/19.0	0.812/20.6
GSP3753TT11	6812012	1/4 inch Butt Weld Tube Stub	316L SS	Penta Nickel	5 Ra, Electro-polished	3750 psig (258.5 barg)	500 psid (34.5 bar)	3.31/84.0	0.75/19.0	N/A
GSP5754FF11	6812005	1/4 inch Male/Male Face Seal	316L SS	Penta Nickel	5 Ra, Electro-polished	3750 psig (258.5 barg)	750 psid (51.7 bar)	5.00/127.0	0.75/19.0	0.812/20.6
GSP5754TT11	6812014	1/4 inch Butt Weld Tube Stub	316L SS	Penta Nickel	5 Ra, Electro-polished	3750 psig (258.5 barg)	750 psid (51.7 bar)	5.00/127.0	0.75/19.0	N/A
GSP5754FF33	6812010	1/2 inch Male/Male Face Seal	316L SS	Penta Nickel	5 Ra, Electro-polished	3750 psig (258.5 barg)	750 psid (51.7 bar)	5.00/127.0	0.75/19.0	0.875/22.2
GSP315H1FF11	6812035	1/4 inch Male/Male Face Seal	316L SS	Penta Nickel	5 Ra, Electro-polished	2500 psig (172.5 barg)	500 psid (34.5 bar)	3.31/84.0	1.50/38.1	1.062/26.9
GSP315H3FF11	6812037	1/4 inch Male/Male Face Seal	316L SS	Penta Nickel	5 Ra, Electro-polished	2500 psig (172.5 barg)	500 psid (34.5 bar)	3.31/84.0	1.50/38.1	1.062/26.9
GSP315H3FF33	6812070	1/2 inch Male/Male Face Seal	316L SS	Penta Nickel	5 Ra, Electro-polished	2500 psig (172.5 barg)	500 psid (34.5 bar)	3.31/84.0	1.50/38.1	1.062/26.9
GSP515H1FF11	6812038	1/4 inch Male/Male Face Seal	316L SS	Penta Nickel	5 Ra, Electro-polished	2500 psig (172.5 barg)	500 psid (34.5 bar)	5.00/127.0	1.50/38.1	1.062/26.9
GSP515H1FF33	6812048	1/2 inch Male/Male Face Seal	316L SS	Penta Nickel	5 Ra, Electro-polished	2500 psig (172.5 barg)	500 psid (34.5 bar)	5.00/127.0	1.50/38.1	1.062/26.9
GSP515H3FF11	6812039	1/4 inch Male/Male Face Seal	316L SS	Penta Nickel	5 Ra, Electro-polished	2500 psig (172.5 barg)	500 psid (34.5 bar)	5.00/127.0	1.50/38.1	1.062/26.9
GSP515H3FF33	6812034	1/2 inch Male/Male Face Seal	316L SS	Penta Nickel	5 Ra, Electro-polished	2500 psig (172.5 barg)	500 psid (34.5 bar)	5.00/127.0	1.50/38.1	1.062/26.9

*Custom designs and fittings available. Contact a Mott representative for more information.

SPECIFICATIONS

Particle Removal Size:	≥ 0.0015 µm
Filter Efficiency (Log Reduction Value):	≥ 9 LRV (99.9999999% reduction in particles). Confirmed at the most penetrating particle size of 0.08 µm per SEMI F38-0699 test method
Helium Leak Rating:	1 x 10 ⁻⁹ atm cc/sec
Moisture Contribution:	<10 ppb after 1 hour at low-flow ambient purge per SEMI F27 test method
Total Hydrocarbons:	Below detectable limits per ASTM F1398 test method
Particle Shedding:	Zero particle contribution above background (<1 particle/ft ³) per SEMI F43-0308 test method
Maximum Operating Temperature	450° C

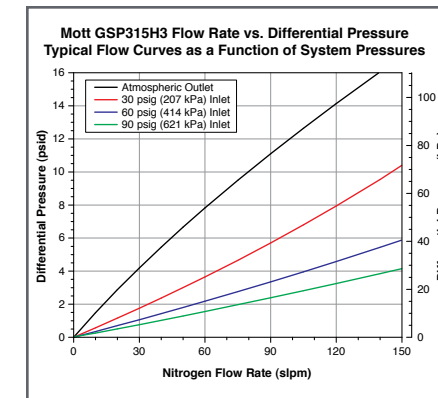
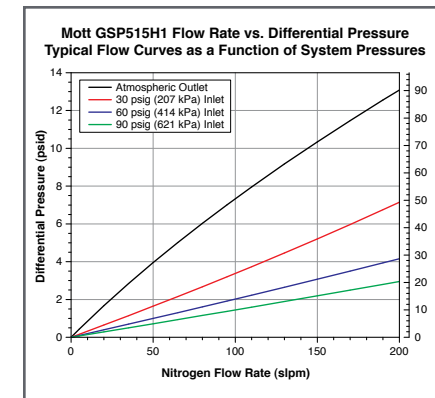

WARRANTY

Mott Corporation ("Mott") warrants its GasShield filter will meet the specified retention and media integrity standards for a period of five years from the date of purchase, providing the filter is properly installed and used in accordance with the specified flow, pressure, temperature, and chemical compatibility as published by Mott. Mott will replace or grant a purchase price refund for any GasShield filter which proves defective under the terms of this limited warranty.

No other remedies apply. Mott disclaims all other warranties, either expressed or implied, including any warranty of merchantability or fitness for a particular purpose. Mott shall have no liability for consequential incidental, special or punitive damages, lost profits or savings, or damages from lost production or damage to other materials.

PENTA®



GasShield® Penta® Point-of-Use & Utility Filters (continued)



Description

For high flow gas filtration efficiency, strength, and reliability, GasShield Penta® all-metal gas filters are ideal for ultra high purity gas delivery applications. They are offered in all welded 316L stainless steel housings with Penta® Nickel filter media and are compatible with most high purity semiconductor process gases. These filters provide 9-log filtration of particles down to 0.0015 µm.

Applications

High flow bulk specialty gas supply, ultra high purity gas sticks for semiconductor, LED, photovoltaic and MEMS equipment hookup. Ultra high purity filtration in valve manifold boxes, gas cabinets, tool isolation gas boxes, on-board gas delivery boxes or any process requiring ultra high purity particle removal.

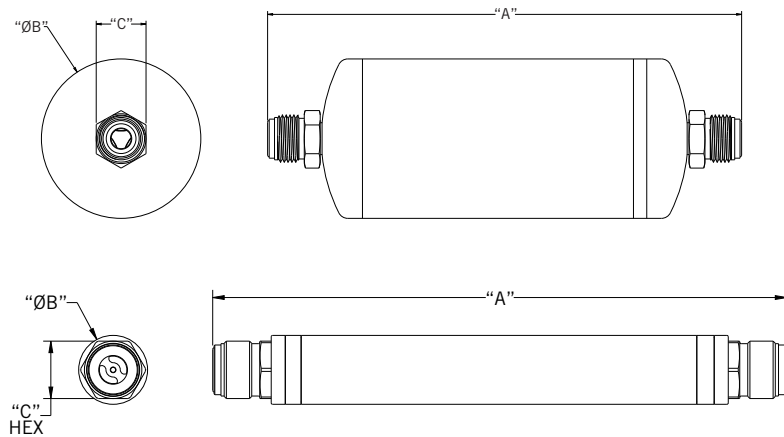

SAMPLE FLOW DATA

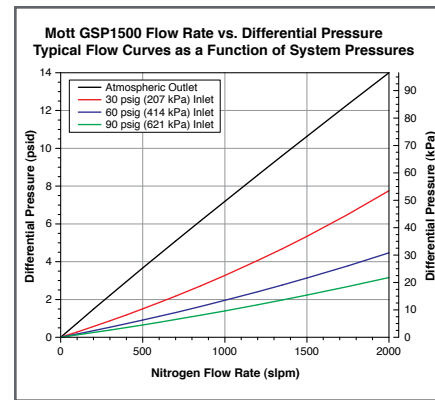
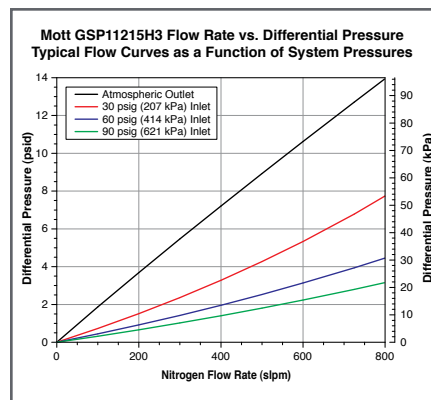
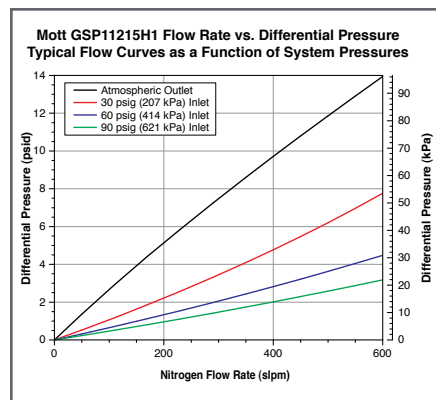

WARRANTY

Mott Corporation ("Mott") warrants its GasShield filter will meet the specified retention and media integrity standards for a period of five years from the date of purchase, providing the filter is properly installed and used in accordance with the specified flow, pressure, temperature, and chemical compatibility as published by Mott. Mott will replace or grant a purchase price refund for any GasShield filter which proves defective under the terms of this limited warranty.

ORDERING INFORMATION

Part Description	Part Number	Fitting Type	Hardware Material	Filter Media	Surface Finish	Max Operating Pressure	Max Differential Pressure	A Inches/mm	B Inches/mm	C Inches/mm
GSP11215H1FF33	6812042	1/2 inch Male/Male Face Seal	316L SS	Penta Nickel	5 Ra, Electro-polished	2500 psig (172.5 barg)	500 psid (34.5 bar)	11.22/285.0	1.50/38.1	1.062/26.9
GSP11215H1TT33	6812052	1/2 inch Butt Weld Tube Stubs	316L SS	Penta Nickel	5 Ra, Electro-polished	2500 psig (172.5 barg)	500 psid (34.5 bar)	11.22/285.0	1.50/38.1	N/A
GSP11215H3FF33	6812043	1/2 inch Male/Male Face Seal	316L SS	Penta Nickel	5 Ra, Electro-polished	2500 psig (172.5 barg)	500 psid (34.5 bar)	11.22/285.0	1.50/38.1	1.062/26.9
GSP11215H3TT33	6812055	1/2 inch Butt Weld Tube Stubs	316L SS	Penta Nickel	5 Ra, Electro-polished	2500 psig (172.5 barg)	500 psid (34.5 bar)	11.22/285.0	1.50/38.1	N/A
GSP1500FF33	6825075	1/2 inch Male/Male Face Seal	316L SS	Penta Nickel	10 Ra, Electro-polished	650 psig (44.8 barg)	250 psid (17.2 bar)	8.86/225.0	3.00/76.2	0.94/23.8
GSP1500TT33	6825080	1/2 inch Butt Weld Tube Stubs	316L SS	Penta Nickel	10 Ra, Electro-polished	650 psig (44.8 barg)	250 psid (17.2 bar)	9.70/246.4	3.00/76.2	N/A
GSP1500FF44	6825081	3/4 inch Male/Male Face Seal	316L SS	Penta Nickel	10 Ra, Electro-polished	650 psig (44.8 barg)	250 psid (17.2 bar)	10.53/267.5	3.00/76.2	1.31/33.3

*Custom designs and fittings available. Contact a Mott representative for more information.

SPECIFICATIONS

Particle Removal Size:	≥ 0.0015 µm
Filter Efficiency (Log Reduction Value):	≥ 9 LRV (99.9999999% reduction in particles). Confirmed at the most penetrating particle size of 0.08 µm per SEMI F38-0699 test method
Helium Leak Rating:	1 x 10 ⁻⁹ atm cc/sec
Moisture Contribution:	<10 ppb after 1 hour at low-flow ambient purge per SEMI F27 test method
Total Hydrocarbons:	Below detectable limits per ASTM F1398 test method
Particle Shedding:	Zero particle contribution above background (<1 particle/ft ³) per SEMI F43-0308 test method
Maximum Operating Temperature	450° C

PENTA®

Bulk Gas Filters



Description

Mott Bulk Filters provide 9-log filtration of particles down to 0.0015 μm resulting in particle-free gas. In addition, the flow versus differential pressure performance of the filter is equal or superior to the performance of competitive polymer products on the market today.

Applications

Mott provides the high-strength, all-metal solution to filtration requirements for gas flow streams at the gas pad. Mott Bulk Filters are ideally suited to the higher temperatures that can be encountered downstream of a purifier during heated dry down operations.

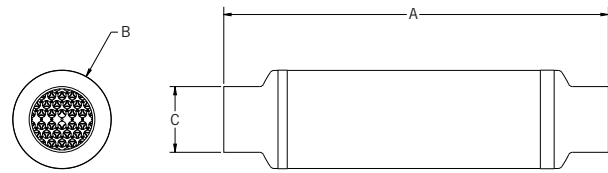

SAMPLE FLOW DATA

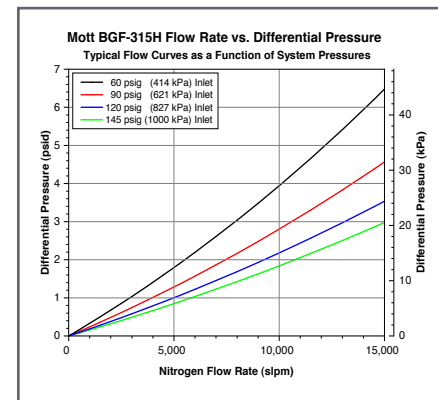
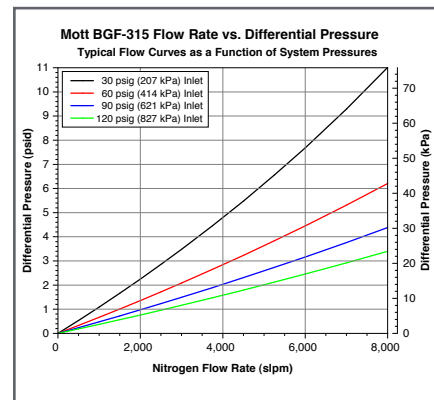
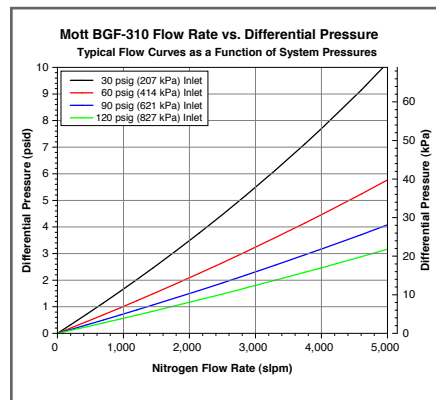

ORDERING INFORMATION

Part Description	Part Number	Fitting Type	Rated Flow (SLPM)	Hardware Material	Filter Media	Surface Finish	Max Operating Pressure	Max Differential Pressure	A Inches/mm	B Inches/mm	C Inches/mm
BGF-310-1TS-N-4M	6825116	1" Tube Stub	4,500	316L SS	Penta Nickel	10 Ra, Electro-polished	650 psig (44.8 barg)	250 psid (17.2 bar)	25.17/639.3	3.00/76.2	1.00/25.4
BGF-310-2TS-N-4M	6825121	2" Tube Stub	4,500	316L SS	Penta Nickel	10 Ra, Electro-polished	650 psig (44.8 barg)	250 psid (17.2 bar)	17.95/455.9	3.00/76.2	2.00/50.8
BGF-315-2TS-N-6M	6925123	2" Tube Stub	6,500	316L SS	Penta Nickel	10 Ra, Electro-polished	650 psig (44.8 barg)	250 psid (17.2 bar)	22.98/583.7	3.00/76.2	2.00/50.8
BGF-315H-2TS-N-15M	6825164	2" Tube Stub	15,000	316L SS	Penta Nickel	10 Ra, Electro-polished	650 psig (44.8 barg)	250 psid (17.2 bar)	22.98/583.7	3.00/76.2	2.00/50.8
BGF-610-2TS-N-19M	6825311	2" Tube Stub	19,000	316L SS	Penta Nickel	10 Ra, Electro-polished	400 psig (27.6 barg)	250 psid (17.2 bar)	24.86/631.4	6.00/152.4	2.00/50.8
BGF-610-4TS-N-19M	6825312	4" Tube Stub	19,000	316L SS	Penta Nickel	10 Ra, Electro-polished	400 psig (27.6 barg)	250 psid (17.2 bar)	18.40/467.4	6.00/152.4	4.00/101.6
BGF-610H-4TS-N-30M	6825157	4" Tube Stub	30,000	316L SS	Penta Nickel	10 Ra, Electro-polished	400 psig (27.6 barg)	250 psid (17.2 bar)	18.42/467.8	6.00/152.4	4.00/101.6
BGF-615-4TS-N-28M	6825124	4" Tube Stub	28,000	316L SS	Penta Nickel	10 Ra, Electro-polished	400 psig (27.6 barg)	250 psid (17.2 bar)	23.41/594.6	6.00/152.4	4.00/101.6
BGF-615-6TS-N-28M	6825088	6" Tube Stub	28,000	316L SS	Penta Nickel	10 Ra, Electro-polished	400 psig (27.6 barg)	250 psid (17.2 bar)	28.81/731.8	6.00/152.4	6.00/152.4
BGF-615H-4TS-N-35M	6825147	4" Tube Stub	35,000	316L SS	Penta Nickel	10 Ra, Electro-polished	400 psig (27.6 barg)	250 psid (17.2 bar)	23.41/594.6	6.00/152.4	4.00/101.6
BGF-615H-6TS-N-35M	6825146	6" Tube Stub	35,000	316L SS	Penta Nickel	10 Ra, Electro-polished	400 psig (27.6 barg)	250 psid (17.2 bar)	28.81/731.8	6.00/152.4	6.00/152.4
BGF-615HF-4TS-N-60M	6825150	4" Tube Stub	60,000	316L SS	Penta Nickel	10 Ra, Electro-polished	400 psig (27.6 barg)	250 psid (17.2 bar)	23.41/594.6	6.00/152.4	4.00/101.6
BGF-615HF-6TS-N-60M	6825149	6" Tube Stub	60,000	316L SS	Penta Nickel	10 Ra, Electro-polished	400 psig (27.6 barg)	250 psid (17.2 bar)	28.81/731.8	6.00/152.4	6.00/152.4

*Custom designs and fittings available. Contact a Mott representative for more information.

SPECIFICATIONS

Particle Removal Size:	$\geq 0.0015 \mu\text{m}$
Filter Efficiency (Log Reduction Value):	≥ 9 LRV (99.9999999% reduction in particles). Confirmed at the most penetrating particle size of 0.08 μm per SEMI F38-0699 test method
Helium Leak Rating:	1 x 10 ⁻⁹ atm cc/sec
Moisture Contribution:	<10 ppb after 1 hour at low-flow ambient purge per SEMI F27 test method
Total Hydrocarbons:	Below detectable limits per ASTM F1398 test method
Particle Shedding:	Zero particle contribution above background (<1 particle/ft ³) per SEMI F43-0308 test method
Maximum Operating Temperature	450° C

BULK GAS FILTERS

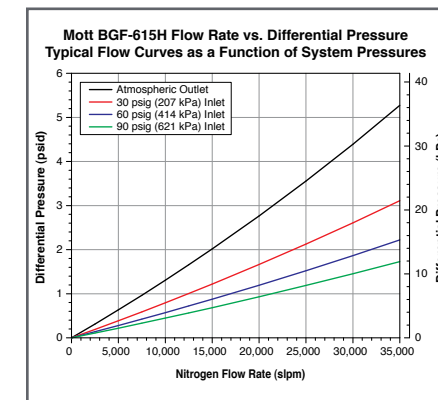
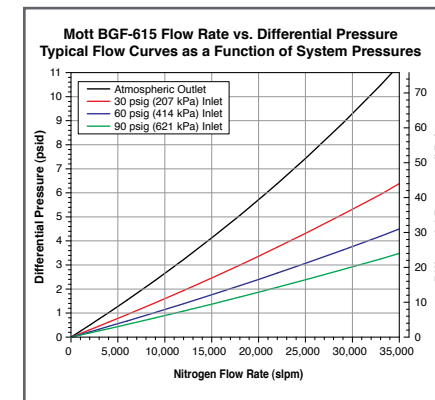

WARRANTY

Mott Corporation ("Mott") warrants its GasShield filter will meet the specified retention and media integrity standards for a period of five years from the date of purchase, providing the filter is properly installed and used in accordance with the specified flow, pressure, temperature, and chemical compatibility as published by Mott. Mott will replace or grant a purchase price refund for any GasShield filter which proves defective under the terms of this limited warranty.

No other remedies apply. Mott disclaims all other warranties, either expressed or implied, including any warranty of merchantability or fitness for a particular purpose. Mott shall have no liability for consequential incidental, special or punitive damages, lost profits or savings, or damages from lost production or damage to other materials.

GasShield® Surface Mount C-Seal Filters



Description

Mott GasShield® Surface Mount Filters provide industry-leading 0.0015 µm filtration for integrated gas systems used on board semiconductor OEM tools. Mott GasShield® products are compliant with SEMI F86-0304 specifications for dimensions of two port components for 1.125" four fastener surface mount gas distribution systems with the C-seal configuration.

Applications

For use with 1.125" C-seal surface mount modular gas delivery systems. Compatible with all inert gases and most specialty gases.

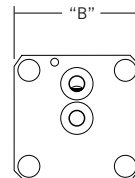
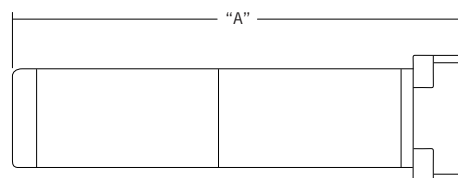

SAMPLE FLOW DATA

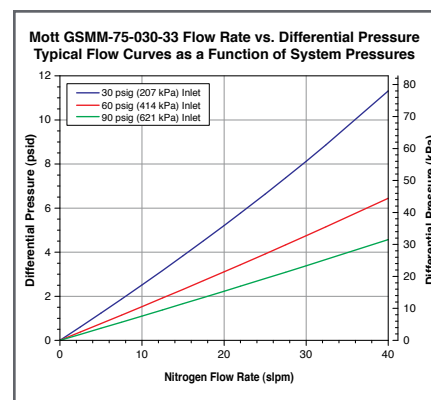
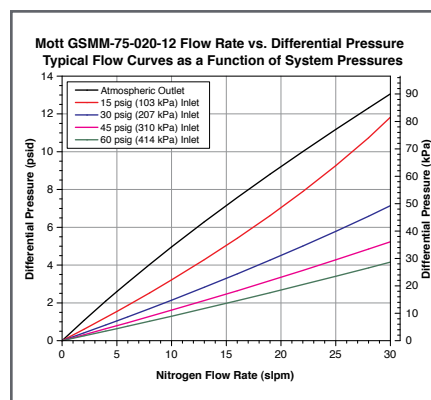

WARRANTY

Mott Corporation ("Mott") warrants its GasShield filter will meet the specified retention and media integrity standards for a period of five years from the date of purchase, providing the filter is properly installed and used in accordance with the specified flow, pressure, temperature, and chemical compatibility as published by Mott. Mott will replace or grant a purchase price refund for any GasShield filter which proves defective under the terms of this limited warranty.

ORDERING INFORMATION

Part Description	Part Number (CPN)	Fitting Type	Rated Flow (SLPM)	Hardware Material	Filter Media	A Inches/mm	B Inches/mm
GSMM-75-020-12	6813032	C-Seal	20	316L SS	Nickel	1.6/40.6	1.125/28.6
GSMM-75-030-12	6813042	C-Seal	30	316L SS	Nickel	2.4/61.0	1.125/28.6
GSMM-75-050-12	6813053	C-Seal	50	316L SS	Nickel	4.0/101.6	1.125/28.6
GSMM-75-010-33	6813056	C-Seal	10	Hastelloy® C-22	Hastelloy® C-22	2.4/61.0	1.125/28.6
GSMM-75-030-33	6813057	C-Seal	30	Hastelloy® C-22	Hastelloy® C-22	4.9/124.5	1.125/28.6

*Custom designs and fittings available. Contact a Mott representative for more information.

SPECIFICATIONS

Particle Removal Size:	≥ 0.0015 µm
Filter Efficiency (Log Reduction Value):	≥ 9 LRV (99.9999999% reduction in particles). Confirmed at the most penetrating particle size of 0.08 µm per SEMI F38-0699 test method
Helium Leak Rating:	1 x 10 ⁻⁹ atm cc/sec
Moisture Contribution:	<10 ppb after 1 hour at low-flow ambient purge per SEMI F27 test method
Total Hydrocarbons:	Below detectable limits per ASTM F1398 test method
Particle Shedding:	Zero particle contribution above background (<1 particle/ft ³) per SEMI F43-0308 test method
Maximum Operating Temperature	450° C

C-SEAL FILTERS



No other remedies apply. Mott disclaims all other warranties, either expressed or implied, including any warranty of merchantability or fitness for a particular purpose. Mott shall have no liability for consequential incidental, special or punitive damages, lost profits or savings, or damages from lost production or damage to other materials.

Hastelloy® is a registered trademark of Haynes International.

GasShield® Surface Mount W-Seal Filters

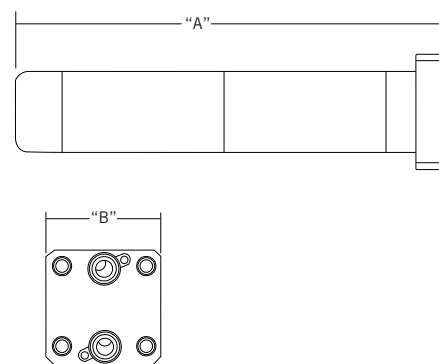

Description

Mott's GasShield® Surface Mount Filters provide industry-leading 0.0015 µm filtration for integrated gas systems used on board semiconductor OEM tools. Mott GasShield® products are compliant with SEMI F86-0304 specifications for dimensions of two port components for 1.125" and 1.5" four fastener surface mount gas distribution systems with the W-seal configuration.

Applications

For use with W-seal, 1.125" and 1.5" surface mount modular gas delivery systems. Compatible with all inert gases and most specialty gases.

ORDERING INFORMATION

Part Description	Part Number (CPN)	Fitting Type	Rated Flow (SLPM)	Hardware Material	Filter Media	A Inches/mm	B Inches/mm
GSMM-55-010-14	6813168	W-Seal	10	316L SS	316L SS Fiber	2.5/63.5	1.125/28.6
GSMM-55-030-14	6813169	W-Seal	30	316L SS	316L SS Fiber	2.5/63.5	1.125/28.6
GSMM-55-050-14	6813099	W-Seal	50	316L SS	316L SS Fiber	2.5/63.5	1.125/28.6
GSMM-55-020-12	6813075	W-Seal	20	316L SS	Nickel	1.7/43.2	1.125/28.6
GSMM-55-030-12	6813076	W-Seal	30	316L SS	Nickel	2.6/66.0	1.125/28.6
GSMM-55-050-12	6813077	W-Seal	50	316L SS	Nickel	4.2/106.7	1.125/28.6
GSMM-55-010-11	6813078	W-Seal	10	316L SS	316L SS	2.6/66.0	1.125/28.6
GSMM-55-030-11	6813079	W-Seal	30	316L SS	316L SS	4.0/101.6	1.125/28.6
GSMM-55-010-33	6813080	W-Seal	10	Hastelloy® C-22	Hastelloy® C-22	2.5/63.5	1.125/28.6
GSMM-55-030-33	6813081	W-Seal	30	Hastelloy® C-22	Hastelloy® C-22	5.0/127.0	1.125/28.6
GSMM-50-010-12	6813036	W-Seal	10	316L SS	Nickel	1.3/33.0	1.5/38.1
GSMM-50-050-12	6813037	W-Seal	50	316L SS	Nickel	2.6/66.0	1.5/38.1
GSMM-50-100-12	6813038	W-Seal	100	316L SS	Nickel	4.5/114.3	1.5/38.1
GSMM-50-010-11	6813028	W-Seal	10	316L SS	316L SS	2.2/55.9	1.5/38.1
GSMM-50-020-11	6813034	W-Seal	20	316L SS	316L SS	3.2/81.3	1.5/38.1
GSMM-50-030-11	6813041	W-Seal	30	316L SS	316L SS	4.1/104.1	1.5/38.1
GSMM-50-075-11	6813035	W-Seal	75	316L SS	316L SS	5.8/147.3	1.5/38.1
GSMM-50-010-33	6813033	W-Seal	10	Hastelloy® C-22	Hastelloy® C-22	2.2/55.9	1.5/38.1
GSMM-50-020-33	6813029	W-Seal	20	Hastelloy® C-22	Hastelloy® C-22	3.2/81.3	1.5/38.1
GSMM-50-075-33	6813031	W-Seal	75	Hastelloy® C-22	Hastelloy® C-22	6.1/154.9	1.5/38.1

*Custom designs and fittings available. Contact a Mott representative for more information.

SAMPLE FLOW DATA

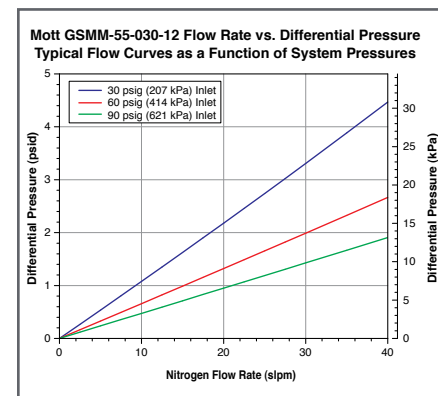
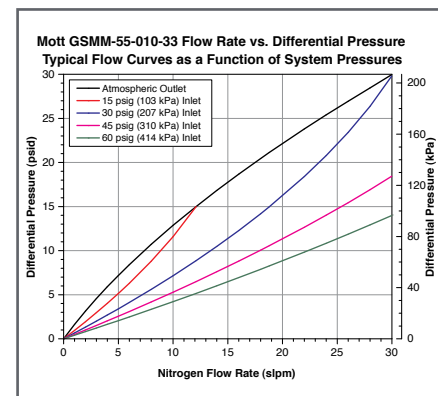
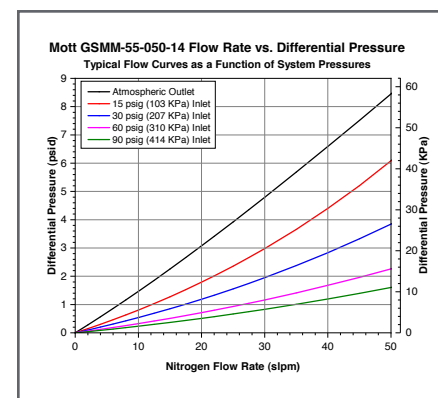
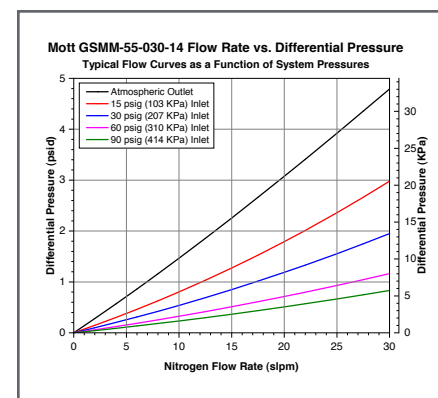
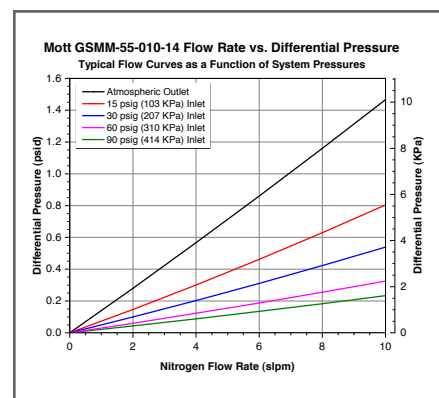

WARRANTY

Mott Corporation ("Mott") warrants its GasShield filter will meet the specified retention and media integrity standards for a period of five years from the date of purchase, providing the filter is properly installed and used in accordance with the specified flow, pressure, temperature, and chemical compatibility as published by Mott. Mott will replace or grant a purchase price refund for any GasShield filter which proves defective under the terms of this limited warranty.

SPECIFICATIONS

Particle Removal Size:	≥ 0.0015 µm
Filter Efficiency (Log Reduction Value):	≥ 9 LRV (99.9999999% reduction in particles). Confirmed at the most penetrating particle size of 0.08 µm per SEMI F38-0699 test method
Helium Leak Rating:	1 x 10 ⁻⁹ atm cc/sec
Moisture Contribution:	<10 ppb after 1 hour at low-flow ambient purge per SEMI F27 test method
Total Hydrocarbons:	Below detectable limits per ASTM F1398 test method
Particle Shedding:	Zero particle contribution above background (<1 particle/ft ³) per SEMI F43-0308 test method
Maximum Operating Temperature	450° C

Hastelloy® is a registered trademark of Haynes International.

W-SEAL FILTERS



GasShield® Diffusers



Description

Mott GasShield® Diffusers quickly vent vacuum chambers to atmosphere which decreases cycle time and increases throughput. Our stainless steel diffusers provide uniform and laminar gas flows without disturbing particles in the chamber. These diffusers also remove particles greater than 0.0015 µm from incoming gas, minimizing defects on the wafer. Stainless steel diffusers can withstand higher operating pressures and maintain product integrity for more than three million cycles – the longest lifetime in the industry. And, for corrosion resistance that is superior to stainless steel and nickel, use Mott GasShield® Hastelloy® C-22 Diffusers.

Applications

Mott Diffusers are used in vent applications on load lock chambers, transfer chambers, cooling chambers, and process chambers of Semiconductor equipment interfaces (CVD, PVD, Etch, Epi) or other vacuum chambers.

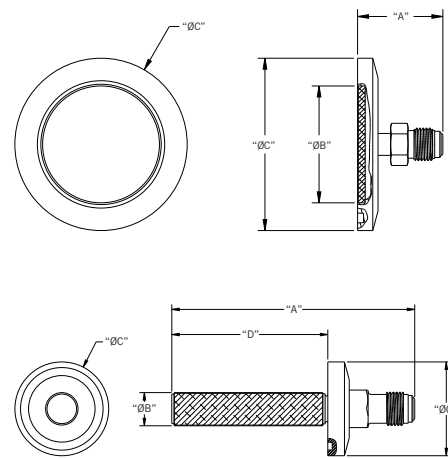

SAMPLE FLOW DATA

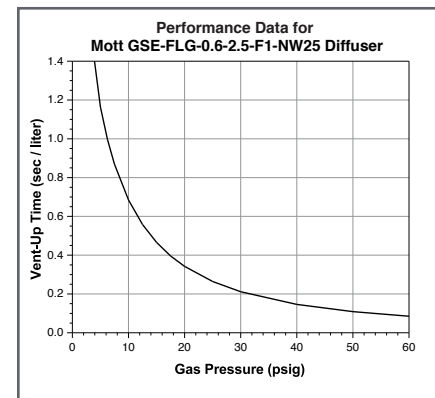
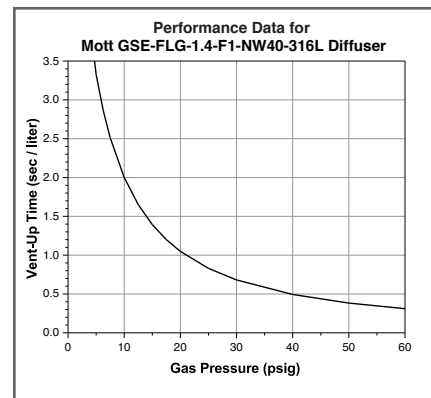
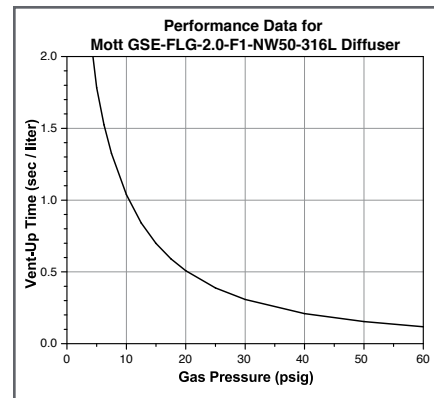

WARRANTY

Mott Corporation ("Mott") warrants its GasShield diffuser will meet the specified retention and media integrity standards for a period of five years or 1,000,000 cycles whichever comes first from the date of purchase, providing the diffuser is properly installed and used in accordance with the specified flow, pressure, temperature, and chemical compatibility as published by Mott. Mott will replace or grant a purchase price refund for any GasShield diffuser which proves defective under the terms of this limited warranty.

ORDERING INFORMATION

Part Description	Part Number (CPN)	Fitting Type	Diffuser Shape	Filter Media	Hardware Material	Outlet Connections	A Inches/mm	B Inches/mm	C Inches/mm	D Inches/mm
GSE-FLG-1.4-F1-NW40-316L	6894036	1/4" (6.35 mm) Male Swivel Face Seal	Disc	316L SS	316L SS	ISO NW40 (Bulkhead mount with standard ISO bulkhead clamps)	1.46/37.0	1.40/35.6	2.16/54.9	N/A
GSE-FLG-2.0-F1-NW50-316L	6894035	1/4" (6.35 mm) Male Swivel Face Seal	Disc	316L SS	316L SS	ISO NW50 (Bulkhead mount with standard ISO bulkhead clamps)	1.46/37.0	2.00/50.8	2.95/74.9	N/A
GSD-FLG-3.6-F1-NW100-0.5-316L	6894045	1/4" (6.35 mm) Male Face Seal	Disc	316L SS	316L SS	ISO NW100 (Bolt through)	1.25/31.8	3.90/99.0	6.50/165.1	N/A
GSE-FLG-2.0-F1-NW50-C22	6894044	1/4" (6.35 mm) Male Swivel Face Seal	Disc	Hastelloy®	316L SS	ISO NW50 (Bulkhead mount with standard ISO bulkhead clamps)	1.46/37.0	2.00/50.8	2.95/74.9	N/A
GSE-FLG-0.6-2.5-F1-NW25	6894039	1/4" (6.35 mm) Male Face Seal	Tube	Nickel	316L SS	ISO NW25 (Bulkhead mount with standard ISO bulkhead clamps)	4.10/104.1	0.50/12.7	1.58/40.1	2.60/66.0
GSE-FLG-0.6-2.5-F1-NW40-316L	6894040	1/4" (6.35 mm) Male Face Seal	Tube	316L SS	316L SS	ISO NW40 (Bulkhead mount with standard ISO bulkhead clamps)	4.20/106.7	0.60/15.2	2.16/54.9	2.74/69.6

Diffusers can be customized according to individual applications. Please contact a Mott representative for more details.

SPECIFICATIONS

Particle Removal Size:	Confirmed down to ≥ 0.0015 µm
Particle Shedding:	Zero particle contribution above background (<1 particle/ft³) per SEMI F43-0308 test method

GASSHIELD® DIFFUSERS



Flow Restrictors



Description

Whatever your priorities in flow control – whether you want low cost, consistent performance, or resistance to clogging – there’s one alternative that will satisfy on all counts: Mott high purity porous metal flow restrictors – featuring Mott porous metal media, developed specifically for semiconductor manufacturing.

Applications

Cost effective replacement for mass flow controllers, needle valves, and other flow control devices where flow conditions remain relatively constant. Ideal for control of purge lines, chamber backfill, and flow splitting. Industry acceptable flow limiting device for hazardous gas lines, allowing for compliance with Semi S2 and S6 standards.

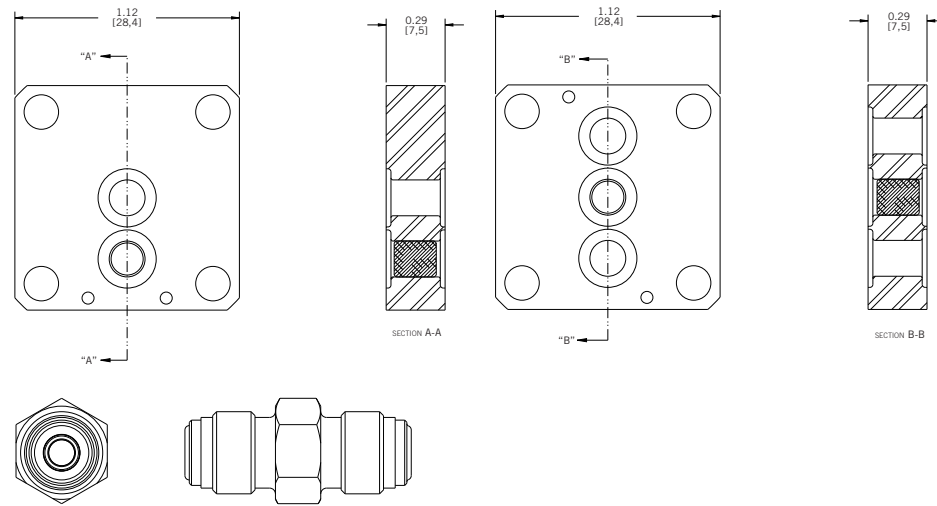

SAMPLE FLOW DATA

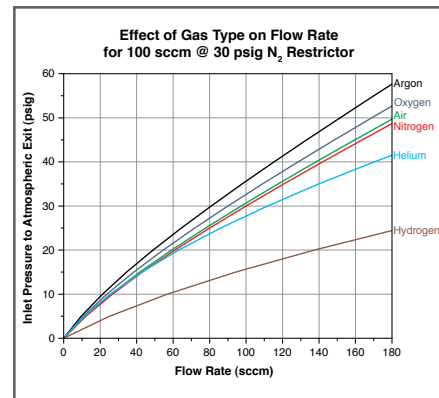

100 SCCM N₂ @ 30 psig

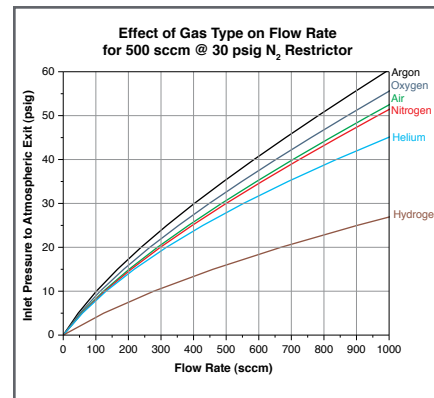

500 SCCM N₂ @ 30 psig

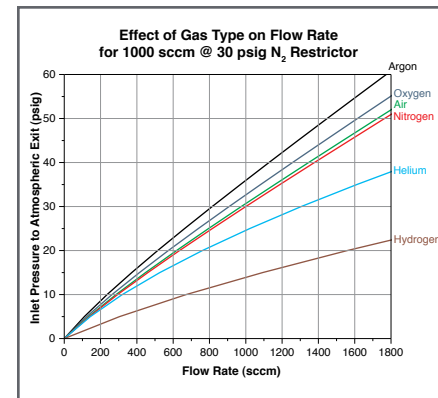

1000 SCCM N₂ @ 30 psig

ORDERING INFORMATION

Product Description	Connection Type
5140-1/4-SS-GASFLOW-INLET PRESS/OUTLET PRESS-CLS100	1/4" (6.35 mm) VCR® Connection
5140-1/2-SS-GASFLOW-INLET PRESS/OUTLET PRESS-CLS100	1/2" (12.70 mm) VCR® Connection
GSMR-20-1-GASFLOW-INLET PRESS/OUTLET PRESS-2 PORT-PORT LOCATION-CLS100	C-Seal Surface Mount 2-Port Connection
GSMR-20-1-GASFLOW-INLET PRESS/OUTLET PRESS-3 PORT-PORT LOCATION-CLS100	C-Seal Surface Mount 3-Port Connection

Flow Restrictors can be customized according to individual applications. Please contact a Mott representative for more details.

SPECIFICATIONS

Flow Ranges Available	0.1 sccm to 40 slpm*
Max Inlet Pressure / Max Differential Pressure	1500 psig
Accuracy	+/- 7.5% Base**
Repeatability	+/- 0.1% of reading
Operating Temperature	Up to 450°C
Warm-up Time	N/A
Wetted Hardware	316L Stainless Steel
Wetted Surface Finish	10 Ra (average)
Leak Integrity (External)	1 x 10 ⁻⁹ atm cc/sec Helium Leak Rating
Fittings (compatible with)***	1/4" Face Seal / IGS 1.125" C-Seal

*Condition specific

**Up to +/- 2% of reading available

***Other Fittings Available on Request

FLOW RESTRICTORS

Lab Testing and Custom Engineering

In working with dozens of semiconductor companies globally over several decades, Mott has developed industry-leading custom engineering, lab testing, and prototyping capabilities. Each day, we design porous metal filters and flow control devices that solve the challenging problems tool manufacturers, wafer fabricators, gas box suppliers and other manufacturers face.

In addition, longstanding customers and newcomers alike rely on our state-of-the-art Customer Innovation Center to help support them in the development of new products and to identify issues or concerns early in the design or manufacturing process.

Our engineers and scientists have amassed decades of experience working with semiconductor companies to resolve complex industry challenges and we are proud to note that one of our team members was responsible for authoring the SEMI F38 specification for particle filtration efficiency.

Mott operates the industry's most advanced equipment and offers comprehensive, in-depth analyses, including:

- **CFD Analysis** – CFD enables our engineers to model various flow and filtration variables (flow distribution, pressure drop, gas velocity and more) prior to product conception, to reduce R&D development and validation time.
- **3D Printing** – With a patent-pending process, Mott is able to produce porous metal parts with complex geometries and precise pore sizes – a process that is not constrained by the limitations of machining or tooling.

- **Filter Efficiency/Challenge Testing Per SEMI F38-0699 (rated flow)** – Evaluation method for point-of-use filters of various media. Typically used for filtering inert and process gases in semiconductor applications. This test method is intended to demonstrate the ability of a point-of-use gas filter to equal or exceed a specific particle filtration efficiency class when challenged with a monodispersed aerosol. The efficiency class of the test method is defined as the log reduction value (LRV).
- **Particle Shed Testing per SEMI F43-0308** – Procedure utilizes a condensation nucleus counter (CNC) applied to in-line gas filters and purifiers typically used in semiconductor applications. Application of this test method is expected to yield comparable data among point-of-use purifiers and filters tested for the purposes of qualification for its installation.

- **SEM/EDAX Analysis** – Provides high resolution imaging of samples and elemental detection of inclusions, debris, stains and contaminants. Useful for analyses of media, identifying areas for improvement, and avoiding potential failure or downtime.
- **Failure Analysis and Lifecycle Testing** – Lifecycle testing on porous parts is capable of measuring the effects of long-term corrosion exposure, pressure cycling and other processes that may alter mechanical integrity. Such testing is critical in determining when parts will likely need replacement and avoiding production downtime resulting from unforeseen complications.
- **Elemental-Chemical Analysis** – Optical Emission Spectroscopy and Wavelength Dispersive X-Ray Fluorescence are capable of bulk, minor, and trace elemental analysis of materials and alloys to determine elemental composition of solids or liquids.

- **Porous Media Characterization** – Measure bubble point, maximum pore size, pore size distribution and flow characteristics of media. With this analysis, we will make recommendations for your specific media to help you achieve the desired specifications for your system.
- **Particle Size Analysis** – Used to determine particle size distribution in order to choose the best filtration media for your application. Critical to maximizing particle capture while minimizing pressure drop in the process.

LAB TESTING AND
CUSTOM ENGINEERING

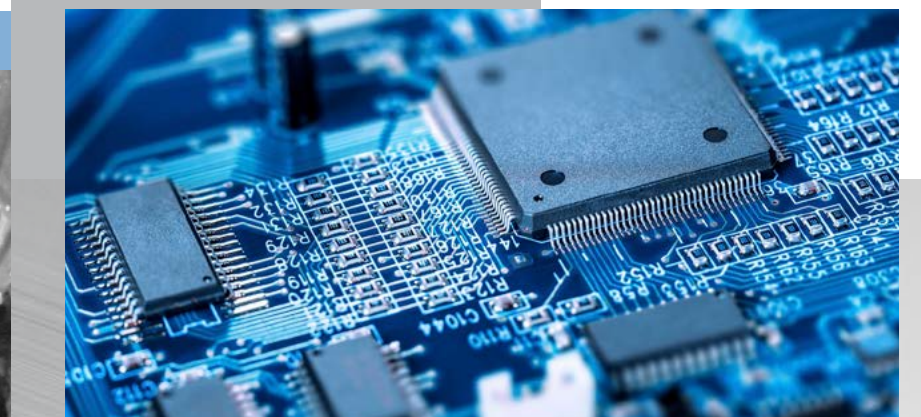
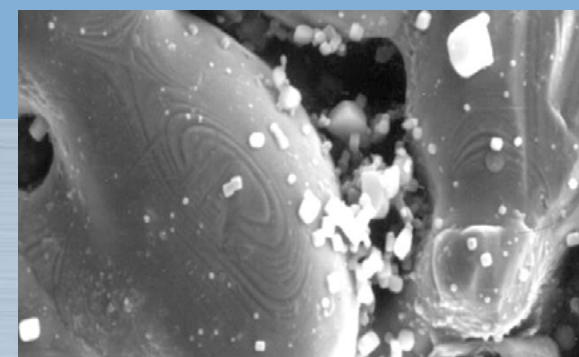
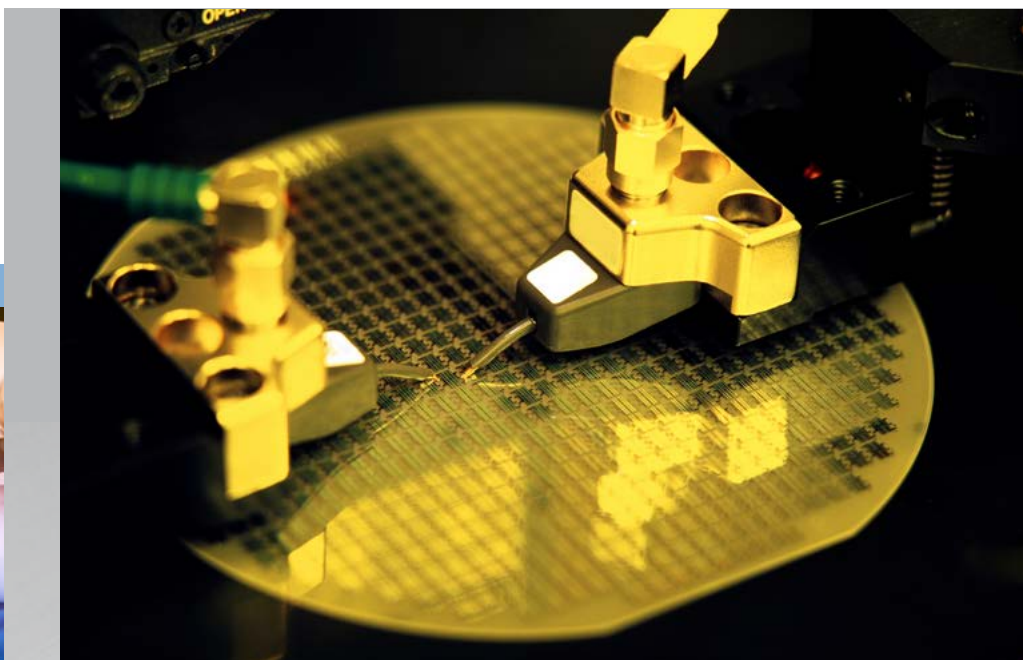
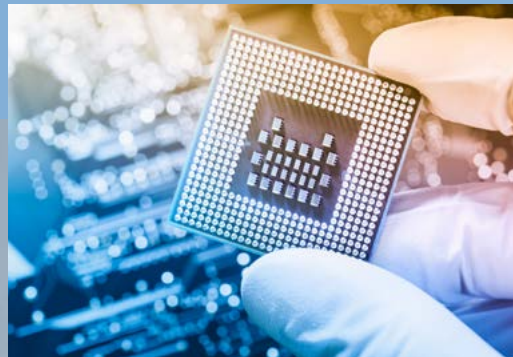



Mott's team of highly-skilled professionals understands the importance of designing, engineering, manufacturing and servicing the best products in the industry, and providing unparalleled technical expertise to our customers.

For more than half a century, Mott has earned a reputation for ironclad reliability, unparalleled application expertise and attention to customer service. Today, we operate two facilities in the United States and partner with a global network of distributors that attend to our customers' needs in all corners of the world.

**1-800-289-6688
1-860-747-6333
info@mottcorp.com**





MOTT CORPORATION

84 SPRING LANE | FARMINGTON CT 06032

860-747-6333 | TELEPHONE

800-289-6688 | TOLL FREE US

INFO@MOTTCORP.COM

MOTTCORP.COM



ISO 9001 CERTIFIED

©2018, Mott Corporation
Penta and GasShield are trademarks of Mott Corporation

HPCAT REV 0618